

SPECIAL TAPES

Studied to satisfy every need in DIY and little home repairs. They are all realized through development and researches policies to obtain the best possible result from their usage.

METALLIZED TAPES

Item 8030 3"



Backing: Metallized BOPP film
Adhesive: Acrylic water-based
Colours: Metallic

- Available with white or transparent adhesive
- Very good insulation to heat and water vapour
- Ideal for fastening tubes and pipes

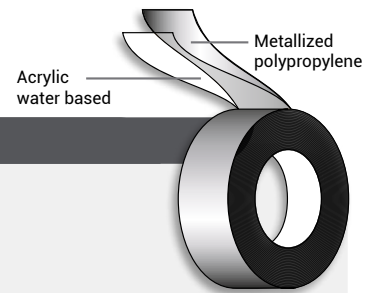

Code	Backing thickness	Total thickness	Width (mm)	Length (m)
8030 3"	30 μ	49 μ	25, 38, 50, 75	50, 66, 100

PE TAPES

Items 7060 - 70100 HT - 70130 HT



Backing: PE
Adhesive: Acrylic water-based
Colour: Transparent, White

- UV Resistance available (6 - 12 months)
- Recommended for splicing and greenhouse repairation
- Excellent moisture barrier

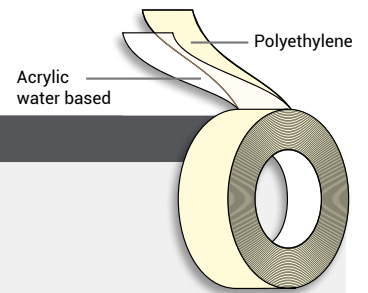

Code	Backing thickness	Total thickness	Width (mm)	Length (m)
7060	60 μ	80 μ	38, 50, 75, 100, 150	25, 50, 100
70100 HT	100 μ	130 μ		25, 50
70130 HT	130 μ	160 μ		

STRAPPING TAPES

Item 9050 - 9080

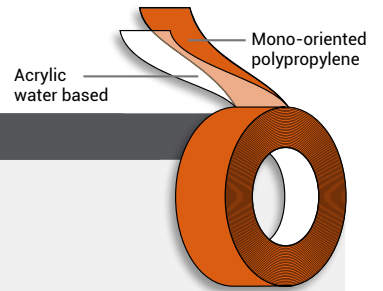

Backing: MOPP film
 Adhesive: Acrylic water-based
 Colours: Orange, Transparent (Black and White available on request)

- Completely free of damaging substances
- High mechanic resistance
- Ideal for generic strapping use

Code	Backing thickness	Total thickness	Width (mm)	Length (m)
9050	50 μ	70 μ	15, 19, 25, 50	66
9080	80 μ	100 μ		

CLOTH TAPES

Item 95

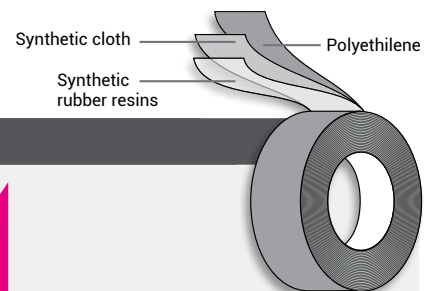

Backing: Polyethylene laminated with Synthetic Cloth
 Adhesive: Synthetic Rubber, Resins
 Colours: Grey (Black available on request)

- Ideal for quick repair and universal use
- Resistant to weather conditions
- Easy tear

Code	Total thickness	Width (mm)	Length (m)
95	165 μ	50	25, 50



REMOVABLE TAPES

Items 6330 - 6340



Backing: BOPP film
Adhesive: Modified acrylic water-based
Colour: Transparent

- Can be easily removed from matted paper, plastic and plastic film
- Subject to prior tests it is removable from glass and steel
- Transparent and very high anti-aging properties

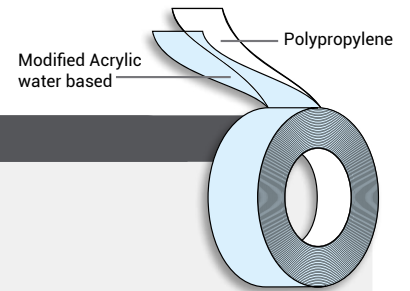

Code	Backing thickness	Total thickness	Width (mm)	Length (m)
6330	28 μ	43 μ	38, 48, 50, 75	66, 100
6340	40 μ	55 μ	38, 48, 50, 75	66, 100

REINFORCED TAPES

Items 66 - 67



Backing: Glassfibre BOPP
Adhesive: Syntetic Rubber, Resins
Colour: Transparent

- High tensile strenght
- Ideal for sealing/reinforcing heavy boxes
- Ideal for generic strapping use: pallets, tube

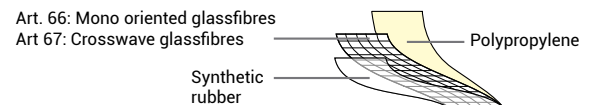

Code	Total thickness	Width (mm)	Length (m)
66 Monodirectional Glassfibre Reinforced	120 μ	19, 25, 38, 50	50
67 Crosswave Glassfibre Reinforced	125 μ		

MASKING TAPES HM GP

Item 60



Backing: Impregnated paper medium creping
 Adhesive: Synthetic rubber, resins
 Colour: Ivory

- Ideal for general purpose and do-it-yourself job, painting at room temperature
- Easy-fitting to various surface
- Doesn't leave adhesive rests

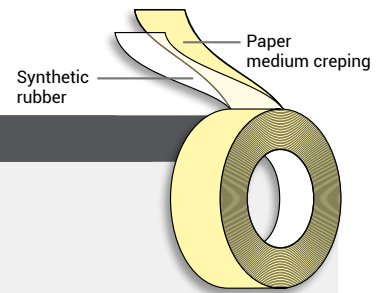

Code	Backing weight	Total Weight	Width (mm)	Length (m)
60	60 gr/mq	86 gr/mq	15, 19, 25, 38, 48, 50	50

MASKING TAPES SOLVENT

Item 60 S

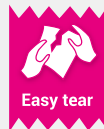

Backing: Impregnated Paper Medium Creping
 Adhesive: Natural Rubber solvent based
 Colours: Ivory

- Suitable for industrial processes, building industry and painting
- It can be used up to 60°C
- Compatible with many kinds of paint and surfaces

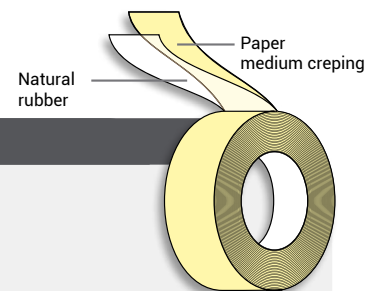

Code	Backing weight	Total Weight	Width (mm)	Length (m)
60S	59 gr/mq	80 gr/mq	15, 19, 25, 38, 48, 50	50

SPECIAL TAPES

MASKING TAPES SOLVENT 80°C

Item 60 S80



Backing: Impregnated paper medium creping
Adhesive: Natural Rubber solvent based
Colour: Ivory

- Suitable for high temperature painting
- It can be used up to 80°C
- Compatible with different types of paint and surfaces

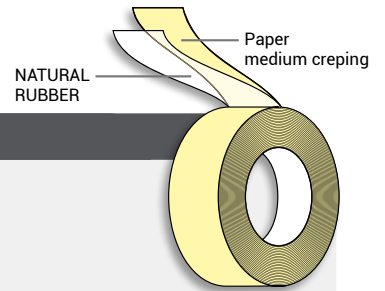

Code	Backing weight	Total Weight	Width (mm)	Length (m)
60 S80	59 gr/mq	95 gr/mq	15, 19, 25, 38, 48, 50	50

BROWN PAPER TAPES

Item 60 SB



Backing: Impregnated paper medium creping
Adhesive: Natural rubber solvent based
Colours: Brown

- Suitable for medium light carton sealing
- Easily hand tearable

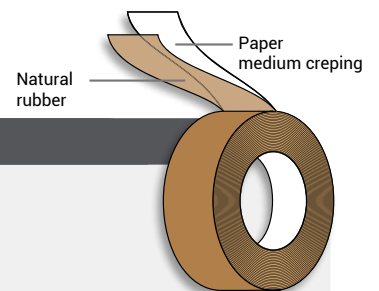

Code	Backing weight	Total Weight	Width (mm)	Length (m)
60 SB	60 gr/mq	87 gr/mq	15, 19, 25, 38, 48, 50	50

SOFT MASKING TAPES

Item 10



Backing: Soft and flexible paper
 Adhesive: Modified Acrylic Water-based
 Colour: Yellow

- Flexible and soft backing, suitable for irregular and rounded surfaces
- Resistant to UV ray and rainproof
- Suitable for external use

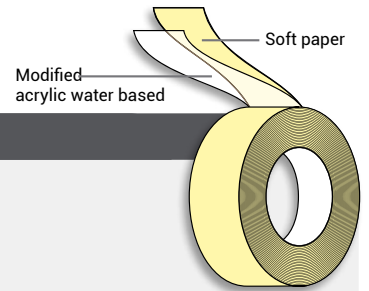

Code	Backing weight	Total Weight	Width (mm)	Length (m)
10	50 gr/mq	85 gr/mq	15, 19, 25, 38, 48, 50	50

BLUE MASKING TAPES

Item 62



Backing: Impregnated Paper Medium Creping
 Adhesive: Modified Acrylic Water-based
 Colour: Blue

- Resistant to weather conditions and rainproof
- Resistant to UV ray
- Suitable for external use

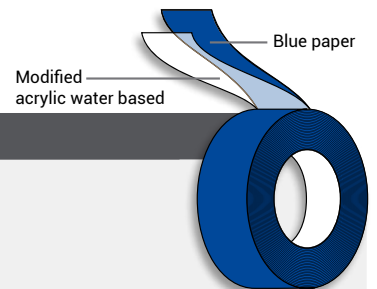

Code	Backing weight	Total Weight	Width (mm)	Length (m)
62	70 gr/mq	105 gr/m	15, 19, 25, 38, 48, 50	50

PVC TAPES

Item 20

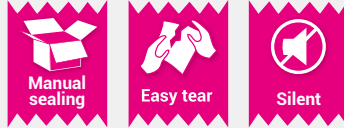

Backing: PVC
Adhesive: Natural Rubber
Colour: Brown, Transparent, White

- No - noise unwinding
- Very good adhesion on several surfaces
- Easy tear by hand

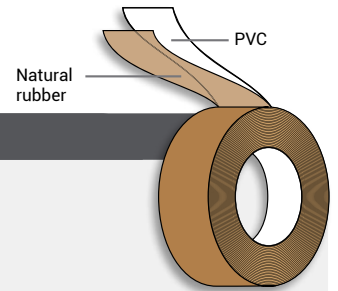

Code	Backing thickness	Total thickness	Width (mm)	Length (m)
20	33 μ	53 μ	38, 48, 50, 75	66

DOUBLE FACED TAPES

Item L1



Backing: BOPP Film
Adhesive: Synthetic Rubber
Colour: Transparent

- Ideal for home-made works and general application
- High adhesion on both sides
- Not resistant to high temperature

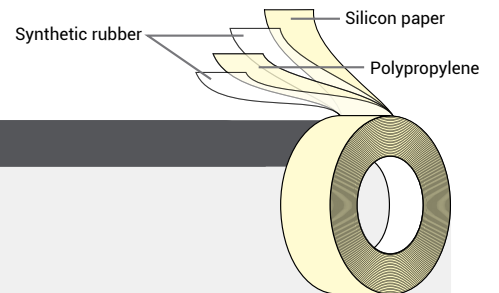

Code	Backing thickness	Total thickness	Width (mm)	Length (m)
L1	/	98 μ	19, 25, 38, 50	50

DOUBLE SIDED TAPES

Item L1SP



Backing: PET gauze
Adhesive: Synthetic rubber, resins
Colour: Transparent

- Suitable for fixing fitted carpeting and carpets
- Easy to anchor to most difficult surfaces
- Easy tear by hand
- Not resistant to plasticizers

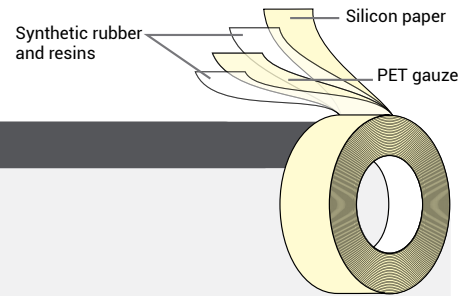

Code	Backing thickness	Total thickness	Width (mm)	Length (m)
L1SP	/	235 μ	19, 25, 38, 50	50

DOUBLE SIDED TAPES

Item M1



Backing: TNT
Adhesive: Synthetic rubber, resins
Colour: Transparent

- Suitable for joining of expanded material, shoe and leather
- It can be used up to 50°C

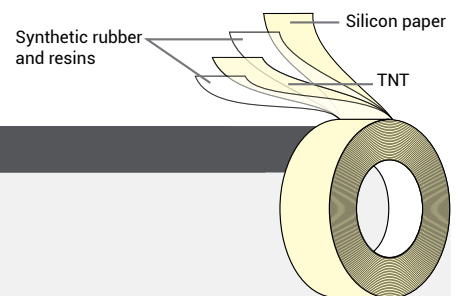

Code	Backing thickness	Total thickness	Width (mm)	Length (m)
M1	/	100 μ	19, 25, 38, 50	50

TAMPER EVIDENT TAPES

Item 4025 PL STP



Backing: Polyester
 Adhesive: Acrylic water-based
 Colour: Red

- Suitable to avoid tampering of the packaging
- Entirely solvent free

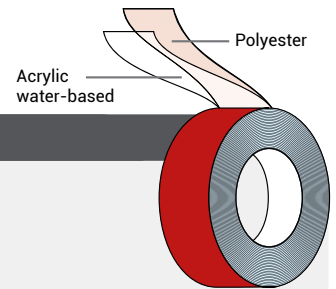

Code	Backing thickness	Total thickness	Width (mm)	Length (m)
4025 PL STP	25 μ	50 μ	50	50

FRONTAL TAPE

Frontal Tape



Backing: BOPP film
 Adhesive: Acrylic water-based

- Totally free from solvent and damaging substances
- Really clear transparent tape with better anti-ageing properties
- We have our own artwork that can be used for standard productions

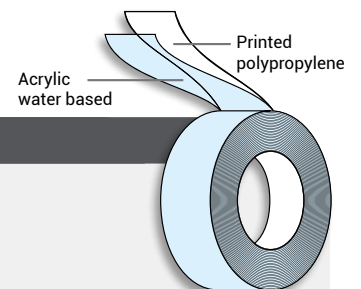

Code	Backing thickness	Total thickness	Width (mm)	Length (m)
Frontal Tape	28 μ	46 μ	Available on request	

SPECIAL TAPES

CARTON FOR PALLET/PALLET SIZE

Code	Length (m)			
	25	50	66	100
6330			72 CRT 80X120X205 84 CRT 80X120X235	54 CRT 80X120X205
6340				
8030				
7060	72 CRT 80X120X205	54 CRT 80X120X205		
70100HT	60 CRT 80x120x205			
70130HT				
95	72 CRT 80X120X205			
60				
60S				
60S80				
60SB				
10				
62				
66				
67				
L1				
L1SP	48 CRT 80X120X170			
M1				
9050		54 CRT 80X120X205		
9080		72 CRT 80X120X205		
20		66 CRT 80X120X205		
4025 PL STP				

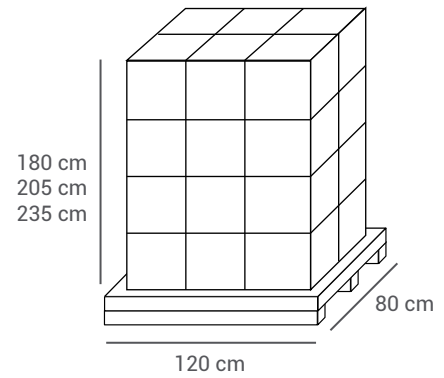

*Important: The drawing shows the pallet dimensions but not the actual quantity of cartons for pallet

ROLLS FOR CARTON

Width (mm)	Rolls	
	Tutti gli articoli	Articolo L1 - L1SP - M1
15	120	
19	96	64
25	72	48
38	48	32
48	36	
50	36	24
75	24	
150	12	

SPECIAL TAPES

